

Installation and maintenance guide



PCP VOLUMETRIC PUMPS CONTROLLER



DAV TECH SRL

Via Ravizza, 30 - 36075 Montecchio Maggiore (VI) - ITALY

Tel. 0039 0444 574510 - Fax 0039 0444 574324

davtech@davtech.it - www.davtech.it

Index

1 INTRODUCTION	pag. 3
1.1 The manual	
1.2 Warranty	
1.3 Goods receiving	
2 TECHNICAL DESCRIPTION	pag. 3
2.1 Description	
2.2 Technical specifications	
3 SAFETY RULES	pag. 4
4 CHARACTERISTICS OF CONTROLLER	pag. 6
4.1 Controller setup	
5 OPERATING MODE	pag. 10
5.1 Operating method	
5.2 Setup "TIME" OPERATING MODE	
5.3 Setup "STEADY" OPERATING MODE	
5.4 Setup "METERING" OPERATING MODE	
5.5 System settings menu (hidden)	
5.6 Calibration function	
5.7 Power supply pressure control function	
5.8 I / O control function	
5.9 Parameter load function	
6 ELECTRICAL DIAGRAM / PIN ASSIGNMENT	pag. 21
6.1 Controller internal composition	
6.2 Controller interfacing	
7 TROUBLESHOOTING	pag. 24

1 INTRODUCTION

1.1 The manual

The user guide is the document that accompanies the Controller from the time of its construction and throughout the period of use, it is therefore an integral part of the Controller. It requires reading the manual before taking any action involving the Controller. The manual must be readily available for use by staff and maintenance of the Controller. The user and the attendant use are required to know the contents of this manual.

Reproduction of any part of this manual, in any form, without the express written permission of DAV Tech. The text and illustrations in this manual are not binding, the DAV tech reserves the right, at any time and without notice, the right to make any changes to improve the product or for reasons of character manufacturing or commercial.

1.2 Warranty

The warranty is valid for a period of 12 months from the date of commissioning and no later than 15 months from the date delivery. The interventions carried out during the warranty period does not extend in any way the validity period of the guarantee. The seller is not liable for defects caused by normal wear of parts which by their nature are subject to wear.

1.3 Goods receiving

The original configuration of the Controller must never be changed. Upon receipt of the goods, check that:

- The packaging is intact
- The exact correspondence of the material ordered.

2 TECHNICAL DESCRIPTION

2.1 Description

The unit is microprocessor-controlled. Really simple to set-up and operate, has 2,5" TFT LCD touch display. All the settings can be easily done trough the controller using the various menu. The controller can be driven externally trough a PLC using I/O signals to change automatically programs.

2.1 Technical specification

ITEM	CONTROL 100
Dimensions	230(W)x90(H)x200(D)
Weight	1.8 Kg
Power In/Output	AC100V - 240V,50/60Hz, DC24V (max.)
Consumption Rating	200VA
Air-in Port	Ø6 Air Hose, Max. 7bar
Air-out Port	Auto Jointer
Pressure Regulator	0~7 bar
Operating Mode	Time / Steady / Metering
Display	2.5" TFT LCD, Touch
Motor Control	1 EA
Liquid Indicator Sensor	OK
External Control	OK
Channel Memory	15 CH
Input Signal	Contact Input or NPN open Collector Tr
Dosing End Signal	NPN open Collector Tr
Operating Temperature	10~40°C

Installation and maintenance guide

3 SAFETY RULES

DANGER

Precautions against Electric Shock

1. This equipment is kept under high pressure for a while even after the main power supply is cut off. When performing a wiring work or inspection that touches all terminals of the terminal block, leave it for at least five minutes after shutting off the power before you start the work.
2. To prevent electric shock and malfunction, please provide Class 3 grounding (100 ohm or less, wire diameter 1.6mm or thicker).
3. Inspection and maintenance of this equipment must be performed by a qualified technician (specialist).
4. Do not inspect equipment with wet hands, when the floor is wet or if there is too much moisture. It may cause electric shock.
5. Be careful not to damage the cable, place heavy objects on it or fold it. In case it is damaged, it may cause electric shock.

Precautions against Fire

1. Do not install this equipment near inflammables, combustible organic solvents or vapors. The heat and electrical operation can cause fire.
2. If this equipment malfunctions, disconnect the main power supply of the equipment. The high current may cause a fire.

Precautions on Wiring

1. Before conducting wiring work for maintenance etc., be sure to shut off all the external power supplies used by the equipment. Failure to do so may result in electric shock or damage to the equipment.
2. To supply power or operate the equipment after wiring, be sure to attach the covers inside and outside the equipment. Failure to do so may result in injury and electric shock.

CAUTION

1. Do not apply main power supply except for that of the voltage specified in this user manual. It may cause malfunction.
2. Make sure that terminal connections and wiring are correct. It may cause malfunction.
3. While the electric current is being applied, do not change the wiring or detach the connector. It may cause injury or equipment failure.
4. If the power wiring in the driving area is wrong, it may cause injury or damage to the equipment due to malfunction. Be careful.

Precautions on Installation

1. Do not install, store and use in places exposed to conductive dust, corrosive gas, flammable gas, high temperature, condensation, wind and rain, etc..
2. Exposure to direct sunlight for a long time will degrade accuracy of the equipment. Do not install, store or use in areas where there is direct sunlight.
3. When installing in an enclosed space, install a separate cooling fan to allow the outside air to flow in and out, in order to maintain the temperature around the equipment at 40°C or less. Overheating may cause fire or other accidents.

Precautions on Use

1. Never modify this equipment. It may cause electric shock, injury, fire or breakdown.
2. Once you modify this equipment, it cannot be covered by our warranty for defects.
3. Before use, be sure to check that all covers are properly installed and verify if there is no foreign material inside the equipment. Depending on the circumstances, unexpected operation can occur and may result in injury.
4. If an alarm occurs during use, remove the cause of the alarm, check the safety, and reuse it.

DANGER

1. When the equipment of our company is used including robots, please be sure to install a safety net in the robot operation area, and never approach the operation area during operation.
2. Equipment of our company include driving and rotating parts. Install a safety net on the rotating parts and never approach it during operation.

CAUTION

Precautions for maintenance and inspection

1. When cleaning or repairing the equipment, be sure to turn off the power and check the internal power supply for complete discharging, and then have it carried out by a qualified maintenance specialist. Maintenance by non-experts can cause breakdown.
2. If there is a breakdown of the equipment, do not disassemble the equipment. Please contact our customer support team.
3. If dust accumulates on the equipment, it may cause malfunction. Clean up the equipment periodically. When cleaning, please shut off the external power completely and check whether the equipment has been fully discharged. There is a danger of electric shock.

CAUTION

Precautions for disposal

1. When this equipment is disposed of, treat it as industrial waste.

DANGER

Precaution

1. Be sure to use the designated power supply. The basic power of the equipment is designated as AC220V 50/60Hz.
2. Be sure to use the designated air pressure. The basic air pressure of the equipment is designated as 5kgf/cm².
3. Do not operate with wet hands. There is a risk of electric shock.
4. During the operation, do not turn off the power or shut down the air pressure unless the equipment is in danger/caution. Serious problems may arise with the use of equipment.
5. Contact us in case of severe errors in the equipment.

4 CHARACTERISTICS OF CONTROLLER

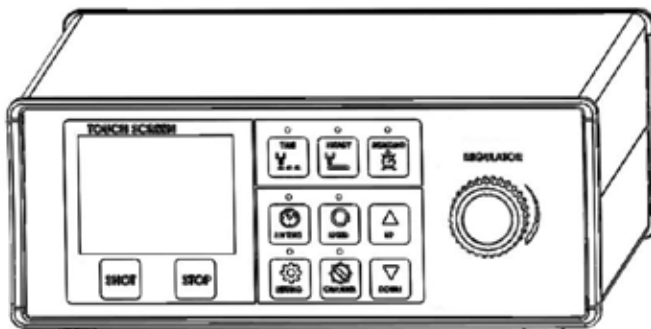





The PCP volumetric pumps allow dispensing fluids with various types of viscosity with maximum repeatability. The Controller allows to set all the dispensing parameters.

- Controller software allows various operation mode.
- Parameters can be easily viewed and controlled by the touch screen monitor
- The memory function (15 channels) allows you to call up different types of programs.
- The external interface allows you to connect to external PLCs for remote control.

> **Please read this manual before use.**

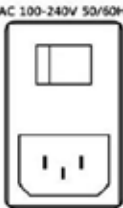
> **This manual is part of the product. Please keep it visible with the device.**

> **In case of loss of this manual, contact us or visit ours website www.davtech.it to be able to download the most recent file.**

 <p style="text-align: center;">Regulator</p> <p style="text-align: center;"><Regulator (Pressure Control)></p>	<ul style="list-style-type: none"> • Supplies the pressure to the Pump in order to replenish materials smoothly. • Self-leveling pressure may not be required for low viscosity.
 <p style="text-align: center;"><Power Switch></p>	<ul style="list-style-type: none"> • Power Switch: Controller Power ON/OFF function • AC Receptacle: Power cord inlet AC 100 ~ 240V, 50 / 60Hz Free Voltage • Be sure to provide grounding.
 <p style="text-align: center;"><Air In port></p>	<ul style="list-style-type: none"> • Air In Port for Ø6 Air Hose. • Supply clean air filtered through a 5μ air filter, with moisture removed. (humidity 5% or less)
 <p style="text-align: center;"><Air Output></p>	<ul style="list-style-type: none"> • Connect the supplied Auto-Jointer to the Air Out.
 <p style="text-align: center;"><Control></p>	<ul style="list-style-type: none"> • It uses Circle 4Pin Connector and outputs the dispensing signal input and dispensing completion signal from the outside. • The dispensing completion signal is output only in the time mode.
 <p style="text-align: center;"><RS232C></p>	<ul style="list-style-type: none"> • D_SUB 9pin connector, used as controller firmware upgrade and debugging mode. (Users do not use it.)

Installation and maintenance guide

4.1 Controller setup

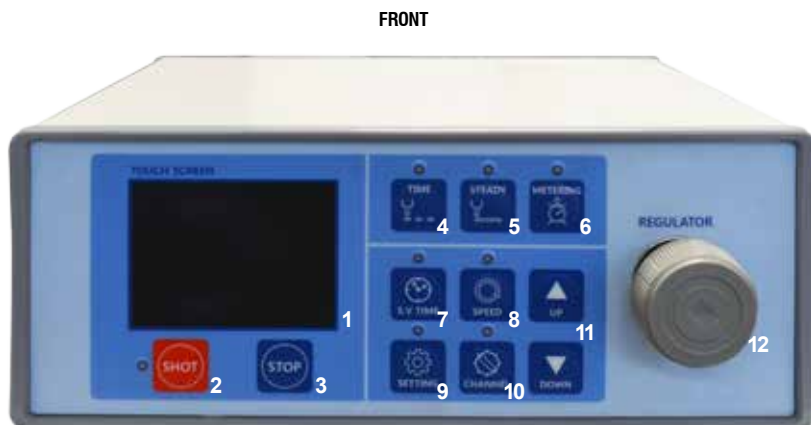

The following table explains each button's function. Please read before use.

NO.	NAME	FUNCTION
1	TOUCH SCREEN	Controls and sets up the data.
2	SHOT	Manual start dispensing
3	STOP	Manual stop dispensing
4	TIME	It allows to manage the dispensing time after setting the pump speed parameters
5	STEADY	It keeps the pump running, at a defined and adjustable speed until the end of the received signal. (suitable to dispense lines)
6	METERING	It allows to dispense a determined quantity, also changing the speed of the dispensing
7	S.V TIME	It allows to control the dosing time in TIME and METERING modes
8	SPEED	It allows to control the speed of the pump in the 3 operating modes
9	SETTING	It allows to enter in the submenus for setting the 3 operating modes
10	CHANNEL	It allows to recall the 15 available channels that correspond to the 15 presettable programs
11	UP/DOWN	Increase or decrease the set values
12	REGULATOR	It allows to adjust of fluid supply pressure

BACK



Connect the controller power cord and turn switch on, then is possible to use the system, at this time the system is ready to be used.

NO.	NAME	FUNCTION
1	POWER SOCKET	Input supply connection 230V
2	AIR OUT PORT	Connect the syringe or cartridge holder to the pressure regulator of the controller
3	AIR IN PORT	Pneumatic power input from the plant circuit
4	MOTOR CONNECTOR	Use the supplied cable to connect the motor
5	CONTROL PORT	Use for remote control
6	RS 232 PORT	<i>In development</i>
7	OUT PUT	Use for remote control

5 OPERATING MODE

1) TIME MODE screen

It allows to manage the dispensing time once the speed parameters, suck back and suck speed have been set.



- Indicates the program number selected.
- Indicates the dispensing time (Max. 9999.99 Sec)
- Indicate the pump speed when dispensing. (0~120 RPM)
- Indicate the suck back time. (0sec: non operative)
- Indicate the pump speed in suck back operation. (0~120RPM)
- It allows to compensate a different % between fluid and water density.
- Indicates the air pressure if you use the pressure regulator inside the Controller.

2) STEADY MODE screen

It keeps the pump running at a defined and adjustable speed until the end of the received signal. (suitable for dispensing lines)



- Indicates the program number selected.
- Indicate the pump speed when dispensing. (0~120 RPM)
- Indicate the suck back time. (0sec: non operative)
- Indicate the pump speed in suck back operation. (0~120RPM)
- It allows to compensate a different % between fluid and water density.
- Indicates the air pressure if you use the pressure regulator inside the Controller.

3) METERING MODE screen

It allows dispensing a determined quantity even when the dispensing speed varies.

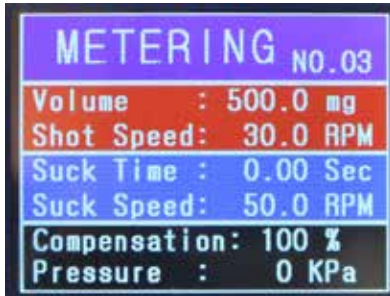

- Indicates the program number selected.
- Indicate the setup dispense amount.
- Indicate the pump speed when dispensing. (0~120 RPM)
- Indicate the suck back time. (0sec: non operative)
- Indicate the pump speed in suck back operation. (0~120RPM)
- It allows to compensate a different % between fluid and water density.
- Indicates the air pressure if you use the pressure regulator inside the Controller.

5.1 Operating method



Controller settings panel

- > Use the Setup keys (4,5,6) to set the operating mode.
 - > After configuring the operating mode, press the SHOT button (2) to dispense.
 - > In TIME mode, to change the dispensing time, press the SV TIME button (7), a light will switch on to indicate that the selected mode is active, with the UP / DOWN buttons (11) while the SHOT TIME display is flashing, select the desired time values.
To confirm, press the S.V TIME button (7) again.
 - > In all operating modes, to change the dispensing speed, press the SPEED button (8), a light will switch on to indicate that the selected mode is active, with the UP / DOWN buttons (11) while the display is flashing, select the desired speed.
To confirm, press the SPEED button (8) again.
 - > To change the various programs press the CHANNEL button (10), a light will switch on to indicate that the selected mode is active, with the UP / DOWN buttons (11) while the program number flashes on the display, select the program number desired.
To confirm, press the CHANNEL button (10) again.
- It is possible to select and use up to 15 programs and set different dispensing conditions for each one.
- > The SETTING button (9) allows to set the specific conditions of the dispensing, at its pressure a warning light will switch on and to indicate that the selected mode is active and at the same time it will enter the programming menu of each of the 3 operating modes (TIME, STEADY , METERING).

Installation and maintenance guide

- > The touch screen display can be used in the programming submenu.
- > By pressing the NEXT button it is possible to navigate through the various parameters to be set, each parameter can be increased or decreased using the UP / DOWN arrows.
- > If the value to be modified is particularly different from the one set, it is possible to press on the numeric field concerned, this leads to the opening of a numeric keypad which can be used to set the desired value



NUMERIC KEYPAD

- > After setting the desired value, confirm with OK or return to the previous screen with ESC.
- > Once the settings have been completed, you can press the EXIT button to save them automatically and return to the control screen of the selected operating mode.

5.2 Setting “TIME” OPERATING MODE

1) Dispensing time setup



- Setting the dispensing time. (0 ~ 9999.99sec)
- Pressing the numeric field to shows the numeric keypad.
- Enter the desired time and press OK.
- Press the NEXT button to go to the next setup menu.
- Press the EXIT button to switch to the main screen.

2) Dispensing speed setup



- Setting the pump speed. (0-120 RPM)
- **ATTENTION the speed must be evaluated based on the viscosity of the fluid.** Contact DAV Tech for advice.
- Pressing the numeric field to shows the numeric keypad.
- Enter the desired value and then press OK.
- Press the NEXT button to go to the next setup menu.
- Press the EXIT button to switch to the main screen.

3) Suck back time setup



- Setting the suck back time. (0~9999.99 Sec)
- **ATTENTION, suck back time must not be too high to avoid a delay in the START of the subsequent dispensing.**
- Pressing the numeric field to shows the numeric keypad.
- Enter the desired value and then press OK.
- Press the NEXT button to go to the next setup menu.
- Press the EXIT button to switch to the main screen.

Installation and maintenance guide

4) Suck speed setup

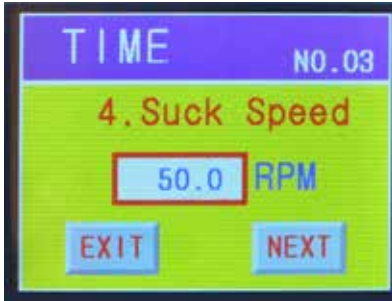

- Setting the suck speed of the pump. (0-120 RPM)
ATTENTION suck speed must be evaluated based on the viscosity of the fluid. Contact DAV Tech for advice.
- Pressing the numeric field to shows the numeric keypad.
- Enter the desired value and then press OK.
- Press the NEXT button to go to the next setup menu.
- Press the EXIT button to switch to the main screen.

5) Compensation values setup



- It allows to compensate in a simple and immediate way the density difference of the dispensed fluid respect to the theoretical water one. This allows to check the correct dispense with a simple scale and without graduated instruments.
- Pressing the numeric field to shows the numeric keypad.
- Enter the desired value and then press OK.
- Press the NEXT button to go to the next setup menu.
- Press the EXIT button to switch to the main screen.

5.3 Setting “STEADY” OPERATING MODE

1) Dispensing speed setup



- Setting the pump speed. (0-120 RPM)
ATTENTION the speed must be evaluated based on the viscosity of the fluid. Contact DAV Tech for advice.
- Pressing the numeric field to shows the numeric keypad.
- Enter the desired value and then press OK.
- Press the NEXT button to go to the next setup menu.
- Press the EXIT button to switch to the main screen.

2) Suck back time setup



- Setting the suck back time. (0–9999.99 Sec)
ATTENTION, suck back time must not be too high to avoid a delay in the START of the subsequent dispensing.
- Pressing the numeric field to shows the numeric keypad.
- Enter the desired value and then press OK.
- Press the NEXT button to go to the next setup menu.
- Press the EXIT button to switch to the main screen.

3) Suck speed setup

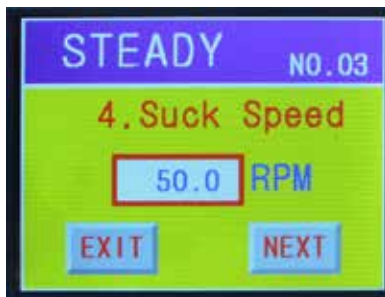

- Setting the suck speed of the pump. (0-120 RPM)
ATTENTION suck speed must be evaluated based on the viscosity of the fluid. Contact DAV Tech for advice.
- Pressing the numeric field to shows the numeric keypad.
- Enter the desired value and then press OK.
- Press the NEXT button to go to the next setup menu.
- Press the EXIT button to switch to the main screen.

4) Compensation values setup



- It allows to compensate in a simple and immediate way the density difference of the dispensed fluid respect to the theoretical water one. This allows to check the correct dispense with a simple scale and without graduated instruments.
- Pressing the numeric field to shows the numeric keypad.
- Enter the desired value and then press OK.
- Press the NEXT button to go to the next setup menu.
- Press the EXIT button to switch to the main screen.

5.4 Setting “METERING” OPERATING MODE

1) Dispensing volume setup



- Setting the dispensed volume in mm³.
- Pressing the numeric field to show the numeric keypad.
- Enter the desired value and then press OK.
- Press the NEXT button to go to the next setup menu.
- Press the EXIT button to switch to the main screen.

2) Dispensing speed setup



- Setting the pump speed. (0-120 RPM)
ATTENTION the speed must be evaluated based on the viscosity of the fluid. Contact DAV Tech for advice.
- Pressing the numeric field to show the numeric keypad.
- Enter the desired value and then press OK.
- Press the NEXT button to go to the next setup menu.
- Press the EXIT button to switch to the main screen.

3) Suck back time setup



- Setting the suck back time. (0–9999.99 Sec)
ATTENTION, suck back time must not be too high to avoid a delay in the START of the subsequent dispensing.
- Pressing the numeric field to show the numeric keypad.
- Enter the desired value and then press OK.
- Press the NEXT button to go to the next setup menu.
- Press the EXIT button to switch to the main screen.

4) Suck speed setup



- Setting the suck speed of the pump. (0-120 RPM)
ATTENTION suck speed must be evaluated based on the viscosity of the fluid. Contact DAV Tech for advice.
- Pressing the numeric field to shows the numeric keypad.
- Enter the desired value and then press OK.
- Press the NEXT button to go to the next setup menu.
- Press the EXIT button to switch to the main screen.

5) Compensation values setup



- It allows to compensate in a simple and immediate way the density difference of the dispensed fluid respect to the theoretical water one. This allows to check the correct dispense with a simple scale and without graduated instruments.
- Pressing the numeric field to shows the numeric keypad.
- Enter the desired value and then press OK.
- Press the NEXT button to go to the next setup menu.
- Press the EXIT button to switch to the main screen.

Installation and maintenance guide

5.5 System settings menu (hidden)

To go to the system setup menu, press and hold the SETTING button on the Controller for at least 2 seconds.



This menu allows you to select some operating parameters of the pump and to check the status of the interface between the pump and the PLC; when the SETTING button is pressed for at least 2 seconds, the screen shown here appears.

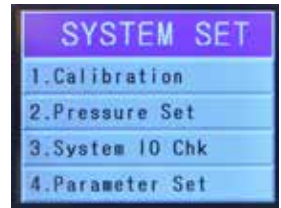

5.6 Calibration function

This function allows you to correct any errors caused by the density of the fluid used.

The theoretical amount of fluid for dispensed rotation is 5, 15, 50, 150, 500, 1000 mm³ depending on the pump model used.

Calibration Method:

- Press the CALIBRATION button from the system settings menu.
- Press the MEASUREMENT button on the touch screen.
- Set a dispensed volume (the theoretical one for each rotation is recommended).
- Set a speed (to be evaluated based on the viscosity of the fluid).
- Dispense by pressing the MESU button.
- Dispense several times (at least 10) and weigh the results obtained with a precision balance.
- Press the EXIT button and return to the previous menu.
- Press the RESULT INPUT button and enter the average value obtained from the weighs.
- Press the SAVE button.

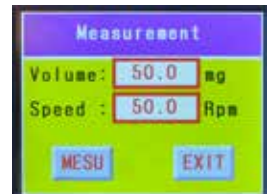

5.7 Power supply pressure control function

This feature allows you to check the pressure of the pump supply system if it is a pressurized syringe or a cartridge holder. Use of this function is at the discretion of the customer.

Regulation method:

- Press the pressure set button from the system settings menu.
- Select the ON mode in the USING SEL screen.
- Press NEXT and set the desired pressure in the numeric field on the keypad that will appear.
- Press OK and then NEXT.
- Set a pressure tolerance value in percent.
- Press NEXT and then EXIT to store the imputed values.



5.8 I / O control function

This function allows to check the correct interface between the I / O and an external PLC.

INPUT control:

- Press SYSTEM I / O CHK
- Press INPUT
- From the external PLC, select the various inputs (ADD 1, ADD 2, ADD 3, ADD 4, ALARM) and check the status change from OFF to ON.
- Press EXIT to return to the previous menu.

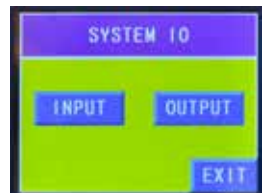

OUTPUT control:

- Press SYSTEM I / O CHK
- Press OUTPUT
- From the touch screen select the various outputs (READY, SHOT, M_ALR, P_ALR, S_ALR) and check the signal status change in the PLC.
- Press EXIT to return to the previous menu.



Installation and maintenance guide

5.9 Parameter load function

This function allows you to select the pump model used by the Controller and to load the related operating parameters.

- Press PARAMETER SET
- Press DISPENSE MODEL until the pump used is selected. (the model of the pump is lasered on the body of the same above the fluid inlet hole).
- Press EXIT and return to the main menu.



WARNING DO NOT MODIFY THE OTHER DEFAULT VALUES SET IN THE CONTROLLER.

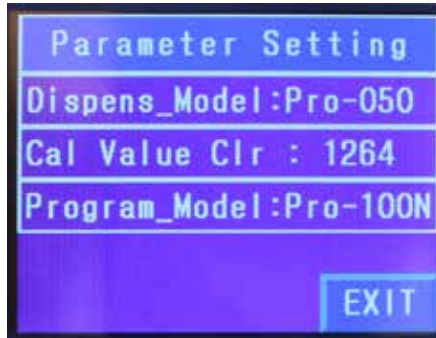

6 ELECTRICAL DIAGRAM / PIN ASSIGNMENT

6.1 Controller internal composition

This scheme summarizes the internal architecture of the Controller.
Opening the Controller or any other tampering is forbidden.

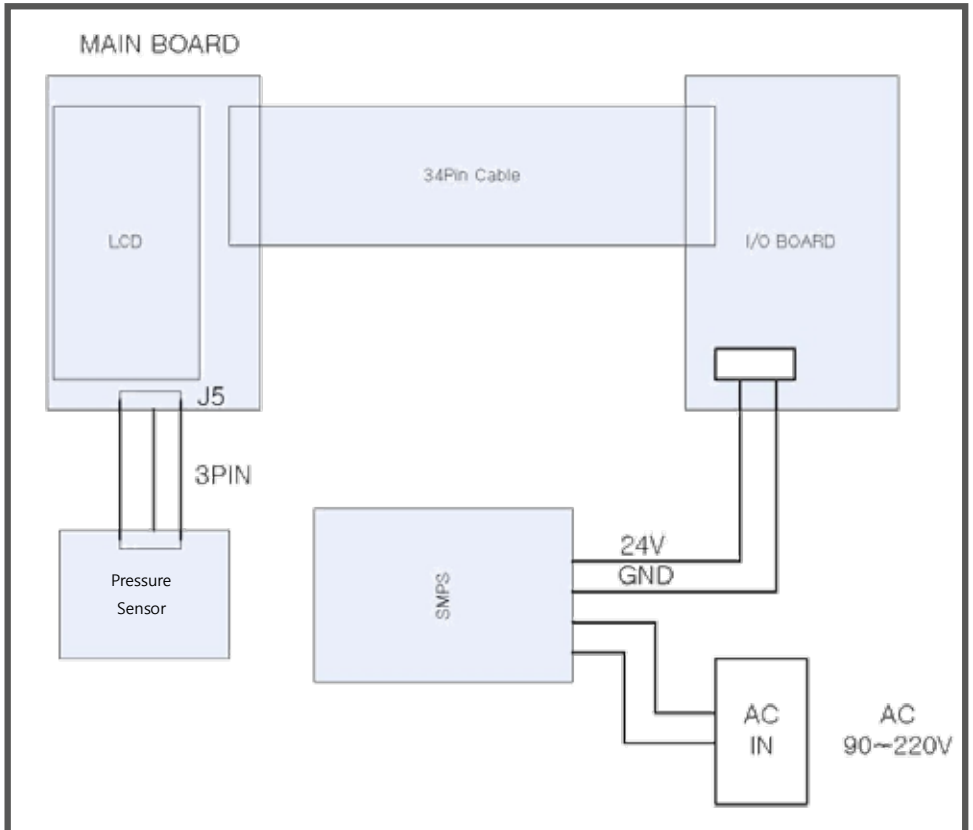

Installation and maintenance guide

6.2 Controller interfacing

The Controller can be interfaced with external PLC or DRIVER to be remotely controlled and to be able to communicate its status in real time.

For this operation there are 2 connectors on the back of the Controller.

Connector control



Pin 1	IN start dispensing (npn)	Dispensing start command
Pin 2	GND	Grounding system
Pin 3	OUT end dispensing (npn or pnp)	Dispensing end pulse
Pin 4	GND or +24VDC	Depending if the input of your PLC is NPN or PNP it must be connected to 0 Volt or 24 Volt respectively.

PIN MAP

- Pin 1 > Start IN
- Pin 2 > GND
- Pin 3 > End dispensing
- Pin 4 > GND

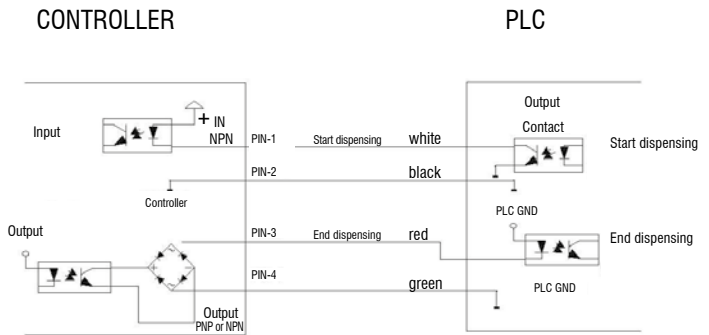

Interface Connector with PLC

Controller status and program selection



Pin 1 (ADD 1)	IN Bit 0 program number	The first 4 PINs allow the remote selection of the desired program (in binary code). Combining these you can choose from the 15 available channels. To select the program from the touch screen, no program must be selected remotely.
Pin 2 (ADD 2)	IN Bit 1 program number	
Pin 3 (ADD 3)	IN Bit 2 program number	
Pin 4 (ADD 4)	IN Bit 3 program number	
Pin 5 (ALARM_CLR)	IN Reset Allarm	Reset any active alarms on the Controller.
Pin 6 (READY)	OUT Ready (station on)	Signals that the controller is running and turns off once the pump is dispensing the fluid.
Pin 7 (SHOT)	OUT dispensing in progress	Indicates fluid dispensing progress. It turns off once the dispensing is finished.
Pin 8 (MOTOR_ALARM)	OUT motor allarm (NC)	Indicates, with the shutdown, a possible incoming motor alarm (motor connector disconnected or motor unable to rotate correctly)
Pin 9 (PRE_ALARM)	OUT warning air pressure (NC)	Indicates that the air pressure at the fluid supply system is insufficient or in any case outside the set range. This control can be disabled from the setting menu.
Pin 10 (SHOT_END)	OUT end dispensing (Control connector signal replication between PIN 3 and PIN4)	It gives an impulse at the end of the dispensing. It can be used to start any movement (removal from the piece).
Pin 11	GND	0 Volt DC - Power supply output from the controller.
Pin 12	+ 24VDC	24 Volt DC - Power supply output from the controller.

7 TROUBLESHOOTING

PUMP TORUBLE	POSSIBLE CAUSE AND CORRECTION
Fail dispense	<ol style="list-style-type: none">1) Check the fluid supply.2) Check the electrical supply of the controller.3) Check if there is fluid.4) Check if the circuit is full of fluid.5) Check that the nozzle is not clogged.6) Check the pump motor rotate freely
The quantity dispensed is not regular	<ol style="list-style-type: none">1) Check to see if there was a change in the controller values setting.2) Check if the fluid has hardened inside the pump chamber.3) Check to see if the nozzle is clogged.4) Check that there are no bubbles in the fluid conduit and inside the pump chamber.5) Check that the fluid supply pressure is sufficient to keep filled the chamber of the volumetric pump.6) Check to see if there is a leak in the fitting of the fluid connection.
The fluid continues to exit from the nozzle at the end of the dispensation	<ol style="list-style-type: none">1) Check if the stator is damaged.2) Check that there are no air bubbles inside the fluid.3) Check that there are no air bubbles in the pump.4) Verify that at rest the motor does not continue to turn.5) Verify that the pressure of the incoming fluid does not exceed from the one shown in the datasheet.
The pump motor does not run	<ol style="list-style-type: none">1) Check the connection of the motor cable.2) Check the setting values of the controller.3) Check that the fluid has not hardened inside the pump.
When fluid leaks out from the body of the pump	<ol style="list-style-type: none">1) Check the gaskets between the chamber and the motor.2) Check the O-ring between the chamber and the gasket block.
The pump make noise	<ol style="list-style-type: none">1) Check to see if the bearings are damaged.2) Check the state of abrasion of the seal block and the rotating seal.3) Check to see if the motor reducer is damaged.